

Operating manual

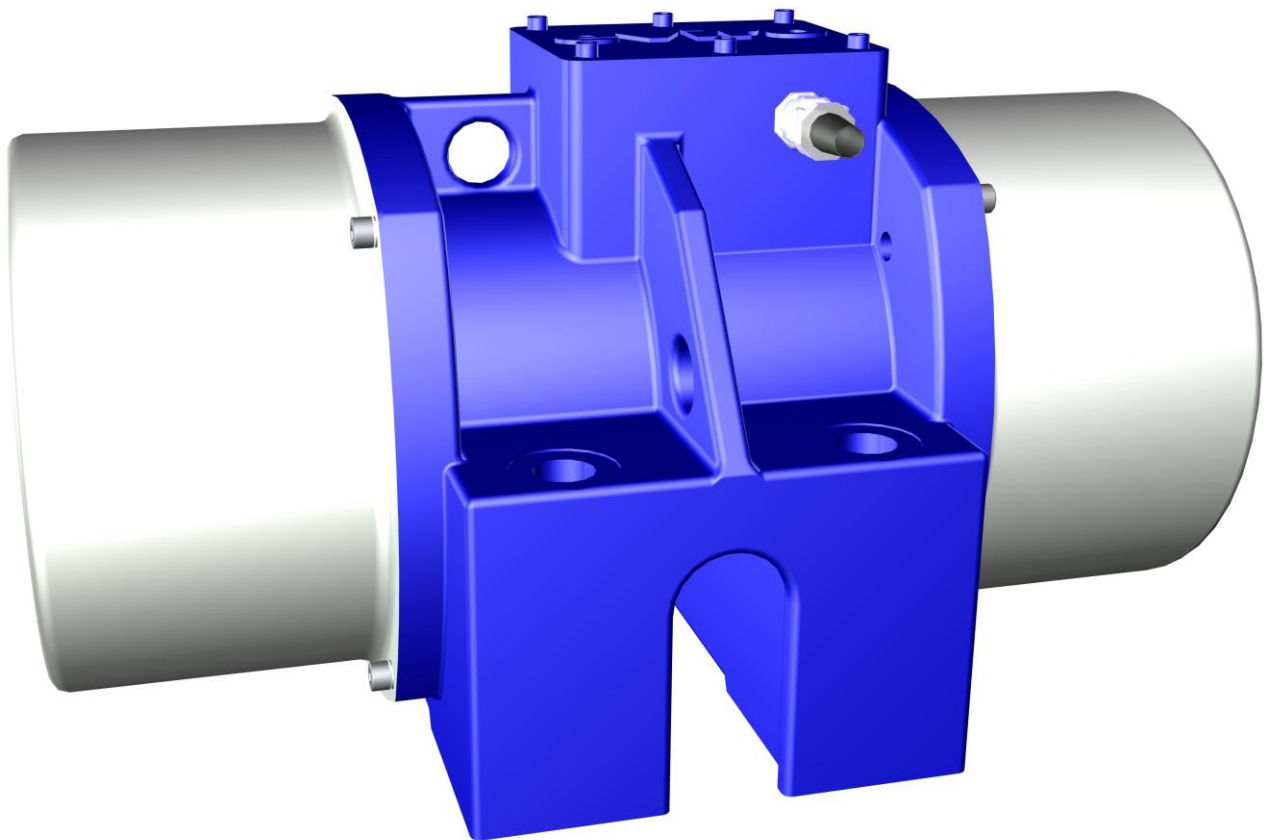

eviro vibration motors Series G32

ID no.: 18.80.000.132101
Issue date: 01.10.2018
Rev. no.: 2



1. Content

1.1. Table of contents

1. Content.....	2
1.1. Table of contents.....	2
1.2. List of figures.....	2
1.3. Annexes.....	2
1.4. Explanation of the symbols used in the operating manual.....	3
2. Identification.....	4
2.1. Name and address of the manufacturer.....	4
2.2. Type designation.....	4
2.3. Declaration of conformity.....	5
3. Product description.....	5
3.1. General functions and application area, intended use.....	5
3.2. Technical data.....	6
3.3. Ambient conditions for storage and operation.....	8
3.4. Safety information.....	8
4. Preparing the product for use.....	9
4.1. Transport and storage.....	9
4.2. Safety measures before use.....	10
4.3. Installing and mounting.....	10
4.3.1. Mechanical installation.....	10
4.3.2. Electrical installation.....	11
5. Operating manual.....	14
5.1. Safe operation / safe function.....	14
5.2. Normal function.....	15
5.3. Adjustment of the centrifugal force of the vibration motor.....	15
6. Maintenance and repair.....	16
7. Decommissioning of the product.....	18





1.2. List of figures

Figure 1 Type plate.....	4
Figure 2 Motor dimensions.....	7
Figure 3 Terminal box allocation 3 ~ 400 V / Δ -switching.....	12
Figure 4 Terminal box allocation 3 ~ 400 V / Y-switching.....	12
Figure 5 Execution of the electrical connections in the terminal box.....	12
Figure 6 Cable installation connection line.....	13
Figure 7 G32 Adjustment of centrifugal force.....	15
Figure 8 G32 Verifying radial clearance.....	17

1.3. Annexes

- Annex 1 – Declaration of conformity
- Annex 2 – Exploded view
- Annex 3 – Spare parts list

1.4. Explanation of the symbols used in the operating manual

<p>NOTE</p>	
	<p>This symbol identifies instructions and notes for the intended use of the product. These instructions and notes have to be observed by the user of the product.</p>
<p>⚠ WARNING</p>	
	<p>This symbol indicates the possibility of severe or irreversible injuries caused by possible dangerous situations.</p>
<p>⚠ DANGER</p>	
	<p>This symbol indicates the possibility of mortal, severe or irreversible injuries caused by the direct hazard of touching high voltage-carrying parts.</p>
<p>⚠ DANGER</p>	
	<p>This symbol indicates the possibility of mortal, severe or irreversible injuries caused by the direct hazard when operating the product in an explosion-prone environment.</p>
	<p>This symbol requests the user of the product to interrupt the mains connections before carrying out any work at the product or machines, plants and devices which are connected to the product, and to secure the connection against unintended reconnection.</p>

2. Identification

2.1. Name and address of the manufacturer

eviro Elektromaschinenbau & Metall GmbH Eibenstock
 Muldenhammer Straße 5
 D-08309 Eibenstock



Phone: +49 (0) 37752 / 3013
 +49 (0) 37752 / 3035
 Fax: +49 (0) 37752 / 3057
 Email: info@eviro.com
 Internet: www.eviro.com



For many years, the company eviro Elektromaschinenbau & Metall GmbH Eibenstock has been developing and producing vibration motors as well as complete modules for electrical drives which live up to the highest quality standards. Its reputation as an innovative and flexible manufacturing company is valued by the customers and many users of the products made by eviro.

2.2. Type designation

The present operating manual refers to vibration motors of the series **G32** by the company eviro Elektromaschinenbau & Metall GmbH Eibenstock from the **serial number 16nnnnnn**.

The corresponding information is given on the type plate of the motor. The type plate is located on the cover of the terminal box. Additionally, the serial number is also embossed in the motor housing below the terminal box.

The information given on the type plate are explained below.

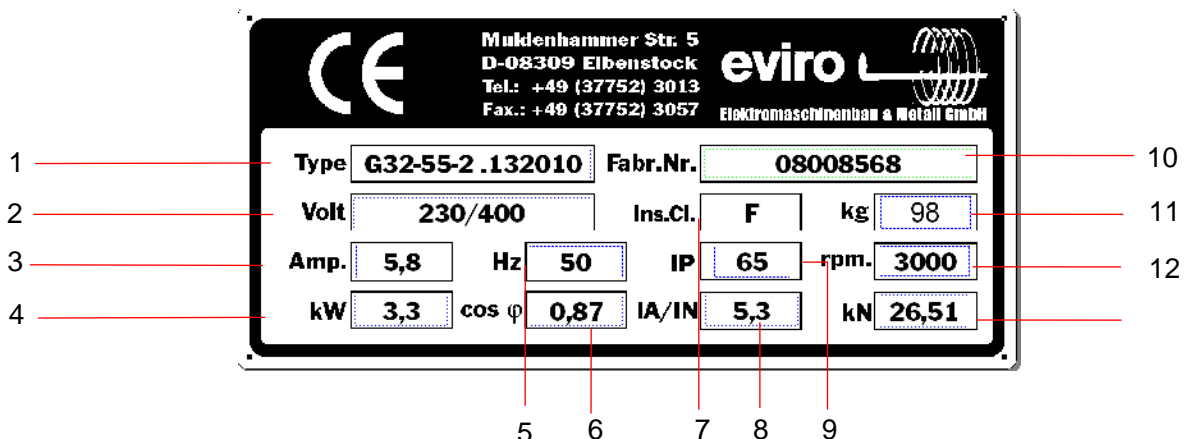

Figure 1 Type plate

1 - Type designation	G	→ Stator housing made of grey cast casting
	32	→ Designation of the series
	55	→ Working torque in kgcm
	2	→ 2-pole
	K	→ Connection cable mounted at the factory
	132010	→ internal Ident-No. (Ordering No.)
2 - Rated voltage in V (Δ / Y)		8 - Ratio starting current – rated current
3 - Rated current at rated speed in A		9 - Type of protection IP65
4 - Power consumption in kW		10 - Serial number
5 - Rated frequency in Hz		11 - Weight in kg
6 - Power factor $\cos\phi$		12 - Rated speed in rpm
7 - Heat insulation class H (180°C)		13 - Centrifugal force at rated speed in kN

2.3. Declaration of conformity

Details on the conformity with the applicable European guidelines and harmonized standards are enclosed to this operating manual in Annex 3.

Vibrating motors do not comply with Article 1, subsection 2, point "k" of Directive 2006/42/EC (Machinery Directive).

3. Product description

3.1. General functions and application area, intended use

The vibration motors of the types G32 are intended for the special use in machines and devices, in which centrifugal forces have to generate vibrations with frequencies of up to 60 Hz.

They are characterized by their compact construction and they have particularly wear-resistant and knock-out-safe bearing shields made of steel, and an grey cast stator housing. Therefore, they can be used in a wide operating temperature range.

During use, it must be ensured that the effective value and the frequency of the operating voltage of the motor must not exceed the values stated on the respective type plate (see 2.2. Type designation) at any time!

Vibration motors must not be operated alienated to drive rotating machine or plant components!

NOTE	Machines or devices into which the motors of the series G32 are installed, may only be put on the market if their conformity with the guideline 2006/42/EC (machinery directive) or equivalent technical guidelines or national regulations in the applicable version was proven.
	

Inappropriate use and disregarding of the instructions in this manual is considered an abuse and is not permitted. In this case, the manufacturer is free from any direct or indirect responsibility.

3.2. Technical data

Rüttelmotoren/vibration motors G32												
Typ Type	Arbeits- moment Working torque	Fliehkraft Centrifugal force	Nenn- spannung Rated voltage	Leistungs- aufnahme Power consumption	Nennstrom Rated current	Leistungs- faktor Power factor	Verhältnis Anlauf- / Nennstrom Ratio starting- / rated current	Netznenn- frequenz Rated mains frequency	Max. Drehzahl (bei f_N) Max. speed (at f_N)	Anzahl Pole Number of poles	Masse Compound	Motorlänge Motor length
	M_A [kgcm]	F [kN]	U_N [V]	P [kW]	I_N [A]	$\cos\phi$	I_A/I_N	f_N [Hz]	n [min ⁻¹]		m [kg]	X [mm]
G32-275-6	276,8	20,99	400	2,08	4,08	0,77	5,50	60	1176	6	133,0	620
G32-400-6	404,3	21,29	400	1,73	3,40	0,77	5,50	50	980	6	133,0	620
G32-340-6	338,8	25,69	400	2,08	4,08	0,77	5,50	60	1176	6	145,0	660
G32-490-6	489,3	25,77	400	1,73	3,40	0,77	5,50	50	980	6	145,0	660
G32-140-4	139,2	23,37	400	2,30	4,03	0,87	8,50	60	1750	4	120,0	480
G32-200-4	201,4	23,54	400	1,92	3,36	0,87	8,50	50	1460	4	120,0	480
G32-175-4	174,6	29,32	400	2,30	4,03	0,87	8,50	60	1750	4	126,0	560
G32-250-4	253,8	29,66	400	1,92	3,36	0,87	8,50	50	1460	4	126,0	560
G32-35-2	35,4	22,73	400	3,96	6,96	0,87	5,30	60	3420	2	103,3	424
G32-50-2	55,8	24,84	400	3,30	5,80	0,87	5,30	50	2850	2	103,3	424
G32-38-2	38,4	24,64	400	3,96	6,96	0,87	5,30	60	3420	2	104,1	424
G32-55-2	55,8	24,84	400	3,30	5,80	0,87	5,30	50	2850	2	104,1	424
G32-45-2	44,9	28,77	400	3,96	6,96	0,87	5,30	60	3420	2	105,0	424
G32-65-2	63,9	28,46	400	3,30	5,80	0,87	5,30	50	2850	2	105,0	424

NOTE



For special designs, the data on the type plate (see 2.2. Type designation) apply!

Table 1 Technical data

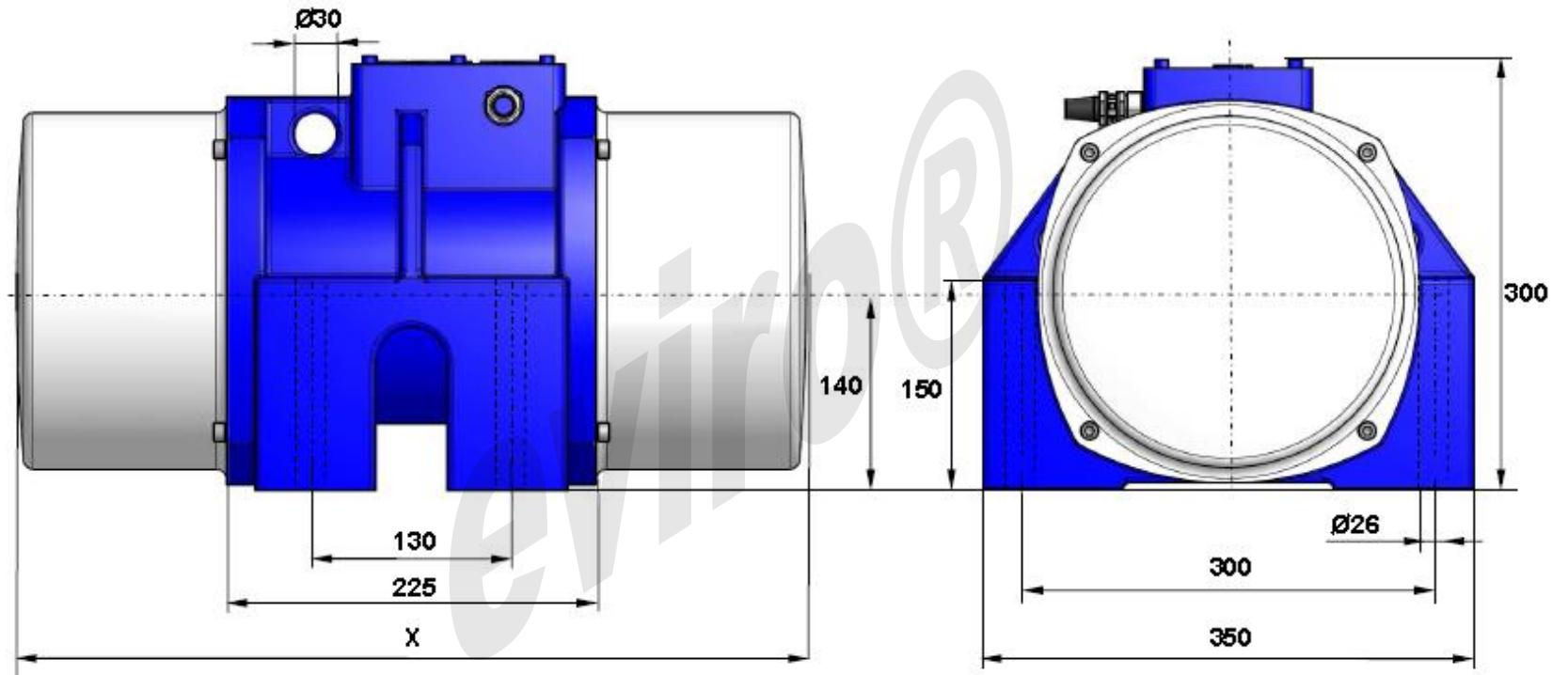

Figure 2 Motor dimensions

3.3. Ambient conditions for storage and operation

	Storage	Operation
Temperature min.	-20°C	-20°C
Temperature max.	60°C	40°C
Rel. humidity max.	60%	80%

Table 2 Permissible ambient conditions for storage and operation

The motors of the series G32 must **not** be used in an explosion-prone area. They are dustproof and water jet-proof according to the type of protection IP65 pursuant to EN 60529 (VDE 0470 /DIN IEC 34, part 5).

3.4. Safety information

NOTE	The present manual has to be read carefully. In doing so, the safety instructions and warning notices have to be observed in particular. At the same time, the applicable national subject-specific safety and accident prevention regulations have to be observed! This operating manual has to be kept in a safe place!
	

▲ DANGER	The motors of the series G32 must not be used in an explosion-prone area.
	

	Before carrying out any work at the vibration motor or the machine, plants and devices connected to the vibration motor, the mains connections have to be interrupted and secured against unintended re-connection. Metal surfaces which might be touched have to be earthed.
---	--

Work on the electrical installation of the vibration motor may only be carried out by specialist electricians.

For electrical work, only voltage isolated electrician tools which comply with the respective national standards and regulations (VDE) may be used.

Any material used for the electrical connection of the vibration motor has to comply with the applicable national standards and regulations.

The mains voltage and the mains frequency have to comply with the respective specifications on the type plate of the vibration motor.

The vibration motor must not be touched during operation!

⚠ WARNING	<p>While plant components are active, avoid areas in which contact with moving parts of the machine might occur. Before entering such an area, the plant has to be switched off and a switch-off or securing process has to be carried out in accordance with the specifications of the plant manufacturer. Staying on plant components subject to vibration is strictly forbidden.</p> <p>Vibration motors can reach an operating temperature of 90 °C during operation. The vibration motor must not be touched during operation. Before touching it, switch off the motor and allow it to cool down! Risk of burning!</p>
	

NOTE	<p>Every intervention in the vibration motor which was not described in this manual will void the safety of the vibration motor and its conformity with the applicable guidelines, standards and rules. This leads to a loss of guarantee and releases the manufacturer from any liability for possibly occurred damages.</p>
	

4. Preparing the product for use

Before carrying out any work at the vibration motor or the machine at which the motor is mounted or shall be mounted, it must be ensured that neither the vibration motor nor the machine is damaged.

4.1. Transport and storage

The vibration motor has to be checked for visible transport damages upon delivery.

NOTE	<p>If the motor shows visible external damages, it must not be taken into operation under any circumstances and must be returned to the manufacturer for inspection and repair. Unauthorised interventions in the motor, except the ones described in this manual, are prohibited!</p>
	

Storage may only be effected in dry rooms.

For the storage, the allowed ground and bearing loads of the storage location have to be observed. It is not allowed to pile up motors or to store other items on the motor.

The allowed ambient conditions for the storage of the vibration motors are described in table 2 of this manual on page 8.

In order to transport individual motors by hand, or within the framework of the assembly process of the motor, it may only be lifted at the stator housing in order to avoid deformations of the protective covers or other components.

⚠ DANGER	
	The motor must not be lifted at already assembled electrical connection cables under any circumstances. This can cause unsafe electrical connections and cable breaks.

4.2. Safety measures before use

Before use, the motor has to be checked for external damages.

NOTE	
	If the motor shows visible external damages, it must not be taken into operation under any circumstances and must be returned to the manufacturer for inspection and repair. Unauthorised interventions in the motor in this regard are forbidden!

For a cable connection which was pre-assembled by the manufacturer, the cable has to be checked for possible damages caused by the transport, and the fixed mounting of the connection line in the terminal box gland of the vibration motor has to be verified.

4.3. Installing and mounting

4.3.1. Mechanical installation

In compliance with the generally known principles of function and operation modes of rotating unbalance vibration exciters, the installation position of the eviro vibration motors is arbitrary. The surface provided for the assembly has to be level and torsion-resistant. For the assembly of the motor at the mounting surface, only use screws M20 of the quality 8.8 or better according to DIN EN ISO 4014 (DIN 931), DIN EN ISO 4017 (DIN 933) or DIN EN ISO 4762 (DIN 912), and if required, hex nuts of the quality 8.8 or better according to DIN EN ISO 4032 (DIN 934). 4 screw points of the motor have to be used respectively. The screwing has to be effected regularly, and alternately crossed using a torque wrench. The tightening torques according to table 3 have to be applied.

Thread marking	Tightening torque in Nm	Mounting of
M20	385	Motor
M12	60	Motor, centrifugal weights
M8	25	Protective covers
M6	10	Terminal box cover
M4	2.9	Electrical connections

Table 3 Required tightening torques for screws (quality 8.8)

For a direct screw connection with the mounting surface, the effective thread length in the un-tempered underground structure (St37) has to be at least twice the screw diameter in mm.

The screw connections have to be mechanically secured against unintended loosening (e.g. by attaching a Schnorr lock washer S20). The tight fit of the screws has to be checked in particular during the initial operating time.

Alternative mounting methods have to be agreed with the manufacturer and are only allowed after the written consent of the manufacturer.

4.3.2. Electrical installation

⚠ DANGER	
	Work on electrical equipment may only be carried out by respectively instructed specialist personnel. Only voltage isolated tools may be used.

In order to establish the electrical connections of the vibration motor, only use flexible cables **HO7RN-F 4G2.5** or equivalent. When operating the vibration motor at an electronic frequency converter, the cable specified by the manufacturer of the frequency converter has to be used. Possibly required shielding has to be connected at the earthing point of the earth wire.

The connections have to implement pursuant to DIN VDE 0100. The connecting cable has to be guided into the terminal box by means of the cable gland. The sheath insulation has to project into the terminal box. In doing so, ensure the tight fit of the cable sheath in the screw connection in order to prevent a rubbing of the cores at the thread hole! In order to connect the individual cable cores, they have to be stripped to approx. 8 mm. Using special crimping pliers, the crimp terminals M4 have to be crimped for a core cross-section $\geq 1.5\text{mm}^2$ (blue). The installation of the wires in the terminal box has to be effected in such a way that they do not contact the terminal box housing and that they are guided to the terminal board bolt in short arches in order to prevent self-oscillations of the cables as far as possible.

NOTE	
	It is forbidden to coat the cable cord with tin for contacting, or to solder on cable lugs!

The green-yellow earth wire (USA: single colour green) has to be mounted on the clamping point marked with the earth symbol. The required small parts for the establishment of the electrical connections are packed in the connection bag which is located in the terminal box upon delivery. The tightening torques of the electrical screw connections have to be 2.9 Nm. With the terminal box wiring shown in the figures 3 to 4, a positive rotation of the motor results (counter-clockwise rotation).

NOTE	
	<p>Fuse elements must not be re-used after disassembly and have to be replaced with new ones!</p>

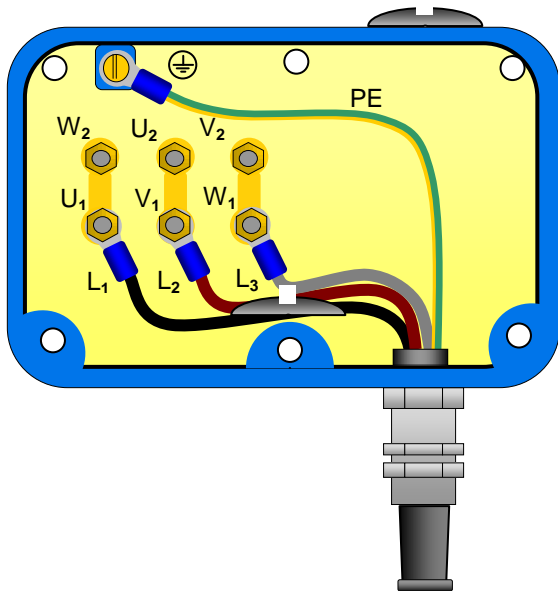

Figure 3 Terminal box allocation
3 ~ 400 V / Δ -switching

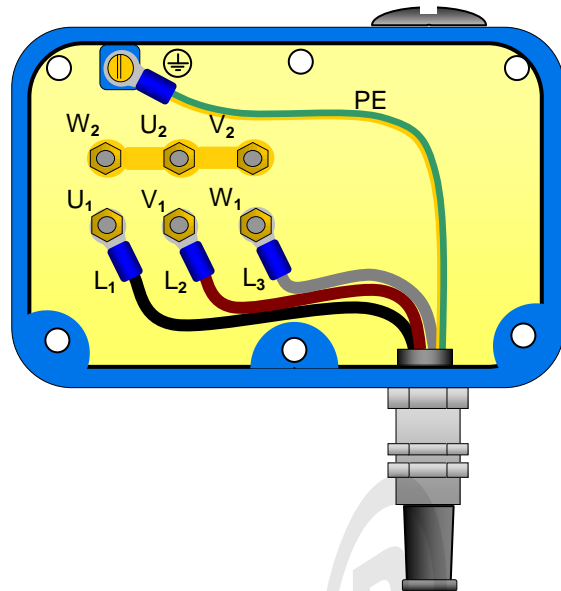

Figure 4 Terminal box allocation
3 ~ 400 V / Y-switching

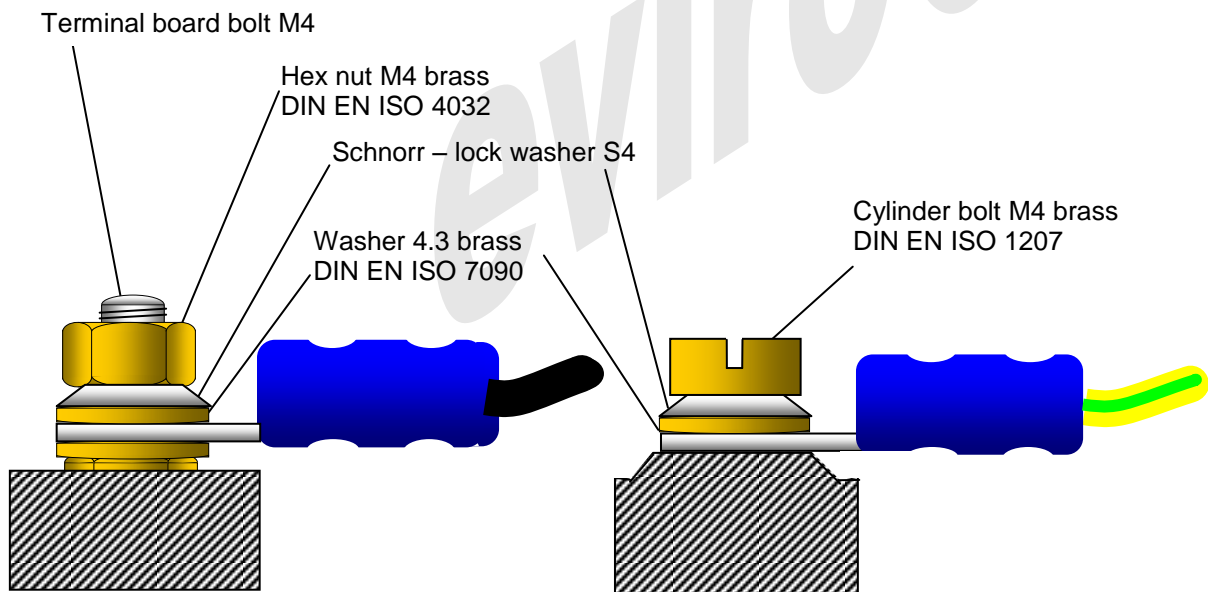

Figure 5 Execution of the electrical connections in the terminal box

After executing the electrical connections, the terminal box sealing has to be attached and the terminal box has to be closed using the terminal box cover. In order to do so, you have to ensure the intactness of the terminal box sealing. Damaged seals have to be replaced.

Every vibration motor has to be operated on a suitable motor circuit breaker. In doing so, rated and start-up current of the motor pursuant to the specifications on the type plate (see 2.2. Type designation) have to be observed in particular. The connection has to be established according to DIN 57100 (VDE 0100).

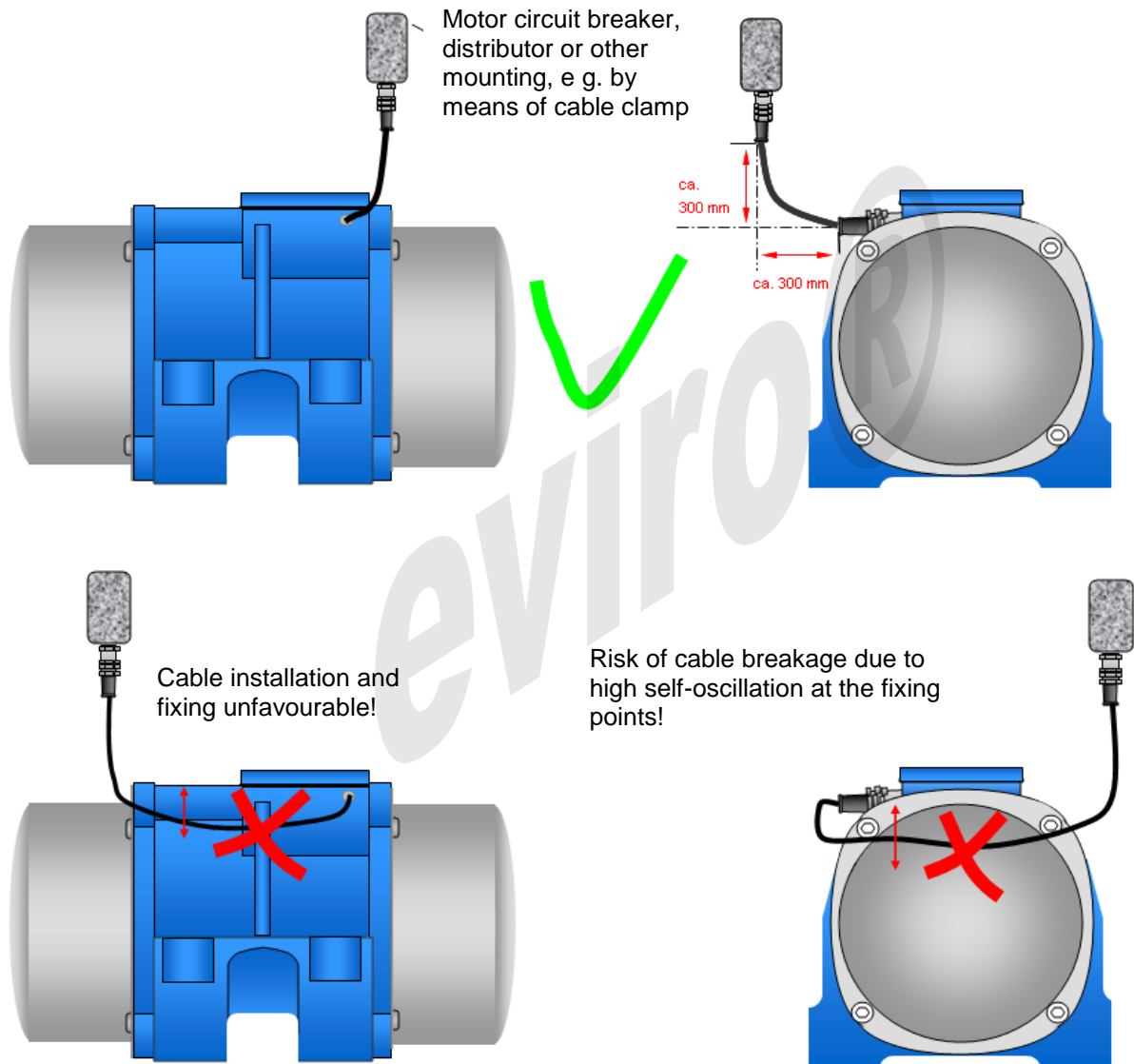



Figure 6 Cable installation connection line

The cable installation at the machine or plant on which the motor is assembled has to be effected in such a way that no self-oscillations of the connection line can occur when operating the motor. The cable has to be protected against contact with sharp components.

When operating the motor on an electrical frequency converter, the respective manual has to be observed. If necessary, suitable measures in order to observe the applicable EMC regulations have to be taken. If the frequency converter contains the motor

protection function, the use of a motor circuit breaker is not necessary. In particular, it has to be ensured that the effective value and the frequency of the operating voltage of the motor do not exceed the values stated on the type plate (see 2.2. Type designation) at any time!

⚠ WARNING	Effective values and frequencies of the operating voltage which are higher the values specified on the type plate can cause the destruction of the motor or the machine on which the motor is assembled.
	

5. Operating manual

5.1. Safe operation / safe function

⚠ WARNING	Vibration motors may only be put into operation when ⇒ The motors were securely attached on a mechanically stable surface acc. to section 4.3.1 of this manual, ⇒ The electrical connections were installed securely according to section 4.3.2 of this manual ⇒ The mechanical safety devices were mounted properly. Do not touch the vibration motors during operation! Allow motors to cool down after switch-off! Risk of burning!
	

The tight fit of the screws has to be checked regularly during operation, for the first time after an operating time of approx. 24 hours.

When commissioning the motor, the power consumption and the housing temperature have to be monitored. If the motor current exceeds the value specified on the type plate (see 2.2. Type designation), or if the housing temperature exceeds a value of 90 °C after a warm-up time of 30 minutes, it is likely that there is a disharmony in the dynamic system of the vibration unit due to which the vibration motor is unable to reach its rated speed. The electric driving power and the set centrifugal force of the vibration motor, as well as the vibration behaviour of the vibration unit have to be synchronized. The vibration behaviour of the vibration unit is mainly determined by its spring damping system and its mass. By means of suitable constructional measures, the resonance behaviour of the overall system has to be designed in such a way that the drive can reach its rated speed. If necessary, the set centrifugal force of the vibration motor has to be decreased (see 5.3. Adjustment of the centrifugal force of the vibration motor).

If these measures are unsuccessful, the manufacturer will be happy to provide support with the handling of such issues.

Interventions in the motor which are not described in this manual are prohibited.

The protective covers provided by the manufacturer serve the protection against touching the rotating centrifugal weights during the operation of the vibration motor. In general, it is forbidden to operate the motor without special protective devices against the touching of rotating parts. If it is necessary to operate the vibration motor without protective covers for plant-specific reasons, the user has to take suitable constructional measures which achieve a protective effect similar to the covers.

5.2. Normal function

⚠ WARNING	Due to the properties and the operating conditions of the machine at which the vibration motor is assembled, the allowed noise levels according to the national regulations might be exceeded. In this case, the operating personnel have to wear suitable ear protection.
	

Due to construction, the rated speed of the vibration motor depends on the frequency of the operating voltage. Therefore, it is possible to adjust the frequency, working torque and centrifugal force of the generated vibrations to the operating conditions via a variation of the frequency of the operating voltage using a frequency converter. In doing so, the values indicated on the type plate (see 2.2. Type designation) specify the allowed maximum values. It must be ensured that the maximum values of operating voltage and supply frequency specified on the type plate are never exceeded!

5.3. Adjustment of the centrifugal force of the vibration motor

Upon delivery, the centrifugal weights are factory-adjusted to the maximum centrifugal force specified on the type plate. If it is necessary to change this presetting centrifugal force generated by the vibration motor can be adjusted. In order to do so, the protective covers of the drive have to be removed on both sides.

For **G32 –series** the adjustment of centrifugal force is done by skewing both of the inboard (next to the end shields) centrifugal weights. To do so, the fixing screws of these centrifugal weights have to be unfastened. It must be observed that the centrifugal weights at both sides of the motor have to be skewed counterwise to the same value. Actual value is to be read on scale (see figure 7 G32 Adjustment of centrifugal force)

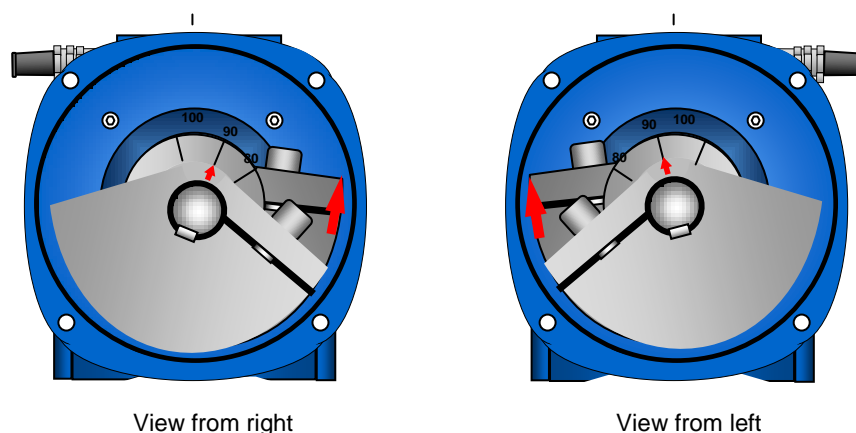



Figure 7 G32 Adjustment of centrifugal force

After adjustment the fixing screws of the centrifugal weights have to be fastened again, and the protective covers have to be attached. Before attaching the protective covers,

the intactness of the sealing rings has to be ensured. Damaged seals have to be replaced. The tightening torques of the screw connections of centrifugal weights and covers have to be observed (see Table 3 Required tightening torques for screws).

NOTE	
	Safety elements must not be re-used after their disassembly and have to be replaced with new ones!

6. Maintenance and repair

▲ WARNING	
	<p>While plant components are active, avoid areas in which contact with moving parts of the machine might occur. Before entering such an area, the plant has to be switched off and a switch-off or securing process has to be carried out in accordance with the specifications of the plant manufacturer. Staying on plant components subject to vibration is strictly forbidden.</p> <p>Vibration motors can reach an operating temperature of 90 °C during operation. The vibration motor must not be touched during operation. Before touching it, switch off the motor and allow it to cool down! Risk of burning!</p>

	<p>Before carrying out any work at the vibration motor or the machine, plants and devices connected to the vibration motor, the mains connections have to be interrupted and secured against unintended re-connection.</p> <p>Metal surfaces which might be touched have to be earthed.</p>
---	---

NOTE	
	<p>The properties and the tight fit of all screw connections and fixtures at the vibration motor have to be checked regularly (min. after 24 operating hours). In order to do so, a suitable, calibrated torque wrench has to be used.</p> <p>The intactness of the electric cables and the safety of all electrical connections have to be checked as well.</p>

NOTE	
	<p>The vibration motor has to be cleaned from dirt and depositions at regular time intervals in order to ensure sufficient cooling. Overheating caused by insufficient cooling can lead to the destruction of the vibration motor.</p>

When observing the provisions of this manual, the operation of the vibration motors of the series G32 is nearly maintenance-free.

The cylindrical roller bearings are equipped with lifetime lubrication. Fittings for re-lubrication during the life cycle of the bearing are not required in this construction and therefore, not provided. The life cycle of the bearing depends on the operating conditions the vibration motor is exposed to. It is mainly influenced by ambient temperatures during operation, the mass ratios of the vibration unit, the loads due to interactions (vibration superimpositions) with other vibration motors (group operation), and rebound impacts of unaccelerated masses in the contact moment to the vibrating system. Therefore, the actual bearing life cycle can strongly deviate from the determined theoretical life cycle. The bearings have to be considered as wear parts whose life cycle depends on the operating loads.

The dimensioning of the bearings is constructed in such a way that 5000 operating hours should be achieved without problems. The theoretical life cycle is exceeded significantly in a large number of applications.

NOTE	
	To prevent consequential damages or plant breakdown the axial and radial clearances of motor shaft have to be verified periodically after 2000 working hours (once a year min.) at both sides of motor see figure 8 Verifying radial clearance).

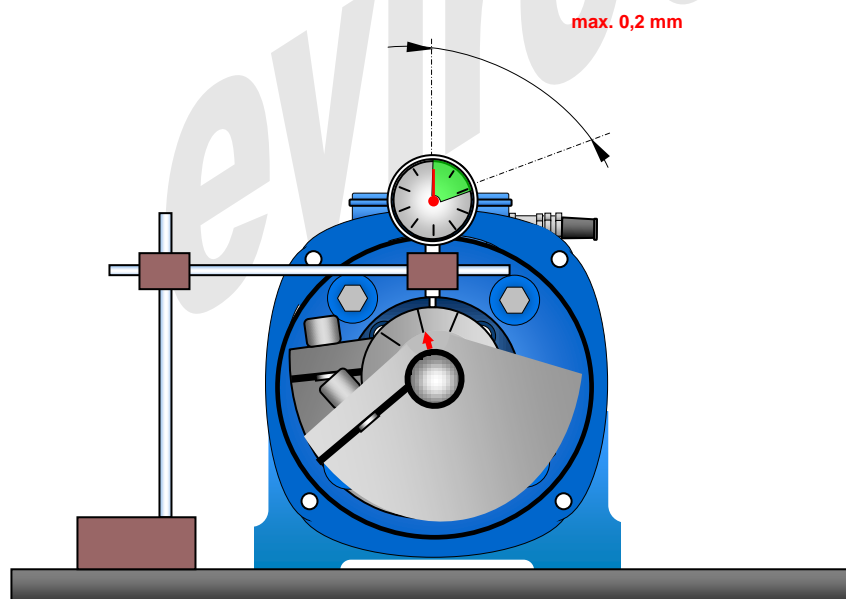



Figure 8 G32 Verifying radial clearance



Bearings have to be changed, if bearing gap is > 0.2 mm.

Axial clearance is allowed to be between $0.5 - 1.5$ mm.

If irregularities occur during the operation of the motor, the motor has to be returned to the manufacturer with an error description which is as precise as possible. Any work for error diagnosis and repair may only be carried out by the manufacturer.

NOTE	
	Every intervention in the vibration motor which was not described in this manual will void the safety of the vibration motor and its conformity with the applicable guidelines, standards and rules. This leads to a loss of guarantee and releases the manufacturer from any liability for possibly occurred damages.

7. Decommissioning of the product

NOTE		
		Eviro vibration motors entirely consist of recyclable materials. Hence, at the end of the life cycle, the motors have to be recycled in a proper and professional manner, or returned to the manufacturer.

eviro®

© eviro Elektromaschinenbau & Metall GmbH Eibenstock

All rights reserved, especially the rights of reproduction, distribution and translation. No part of this publication may be reproduced or processed using electronic systems, copied or distributed in any form without written permission of eviro Elektromaschinenbau & Metall GmbH Eibenstock.

Annex 1 Declaration of conformity

EG-Konformitätserklärung

EC Declaration of Conformity

gemäß EG-Richtlinie Maschinen 2006/42/EG Anhang II Teil 1A

according to EC Directive 2006/42/EC, Annex II Part 1A

Der Hersteller
The manufacturer

eviro Elektromaschinenbau & Metall GmbH Eibenstock
Muldenhammer Straße 5
D-08309 Eibenstock

erklärt hiermit, dass die nachstehend bezeichneten Maschinen
hereby declares that the following machines

Bezeichnung: **Rüttelmotor**
Designation Vibrating motor

Typen: **G3x**
Types

ab Seriennummer: **16nnnnnn**
from serial number

in ihrer Konzeption und Bauart sowie in der von ihm in Verkehr gebrachten Ausführung den
grundlegenden Sicherheitsanforderungen folgender EG-Richtlinien entsprechen:
in their design and construction as well as in the version which they have been placed on the market, complies with the essential
safety requirements of the following EC Directives:

Richtlinien: **2006/42/EG (Maschinenrichtlinie)**
Directives 2006/42/EC (Machinery Directive)
2014/35/EU (Niederspannungsrichtlinie)
2014/35/eu (Low Voltage Directive)
2014/30/EU (EMV-Richtlinie)
2014/30/eu (EMC Directive)

Angewandte harmonisierte
Normen: **EN ISO 12100-1, EN ISO 12100-2, EN 60034,**
Applied harmonized standards **EN 60 204-1**

Angewandte nationale
Normen und technische
Spezifikationen **DIN 57100**
Applied national standards and
technical specifications

Die Einhaltung der Bedingungen der Richtlinie 2014/30/EU (EMV-Richtlinie) setzt einen EMV-
gerechten Einbau der Produkte und die Beachtung der spezifischen Installationshinweise in der
Produktdokumentation voraus.

Compliance with the requirements of Directive 2014/30/eu (EMC Directive) requires EMC-compliant installation of the products and
observance of specific installation instructions in the product documentation.

Bei einer nicht mit dem Hersteller abgestimmten Änderung des Produktes verliert diese
Erklärung ihre Gültigkeit.

In the case of a modification of the product which is not coordinated with the manufacturer, this declaration loses its validity

Eibenstock, den 01.04.2016

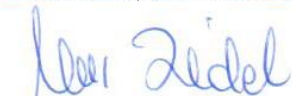

Ullus Leidel
Geschäftsführer
General Manager

eviro®
Elektromaschinenbau & Metall GmbH Eibenstock
Stempel Muldenhammerstraße 5
Company stamp 08309 Eibenstock
Tel. 03 77 52 / 30 13 oder 30 35
Fax 03 77 52 / 30 57

Annex 2 Exploded view

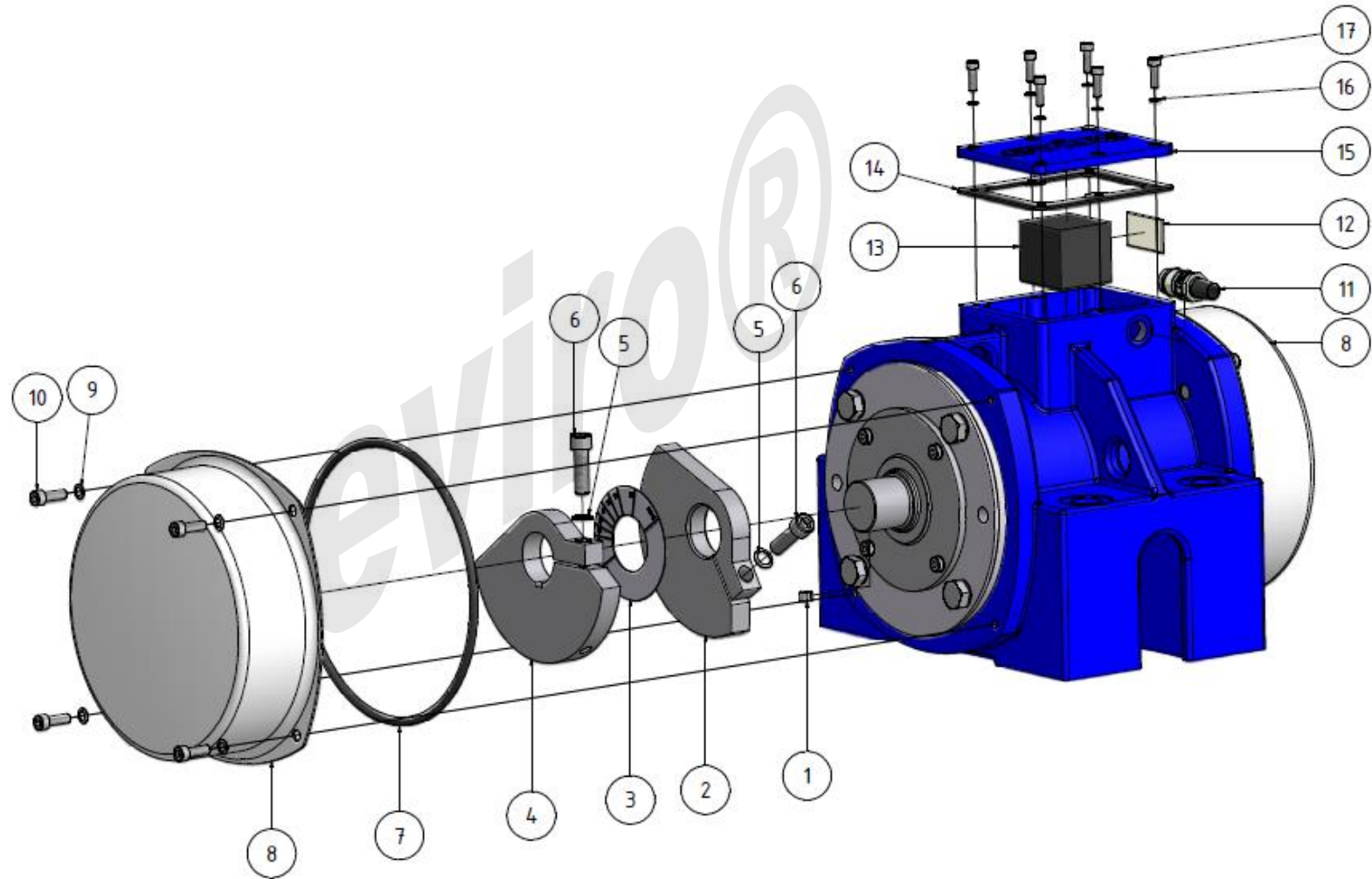

Annex 3 Spare parts list

Rüttelmotor G32					
No.	Count per motor	Designation	Type	Standard	Ordering No.
1	2	fitted key	A8x7x12	DIN 6885	14.80.044.06281946
2	2	centrifugal disk			X
3/18	1	scale type A/ scale type B			14.01.042.1-35-40/14.01.042.2-35-40
4	2	centrifugal disk			X
5	4	schnorr-lock washer	S12		*) 14.01.042.08470140-01
6	4	hexagon socked head cap screw	M12x45	DIN 912	*) 14.01.040.01032886
7	2	washer			*) 14.01.121.0003
8	2	protective hood			X
9	8	schnorr-lock washer	S8		*) 14.01.042.08470124-01
10	8	hexagon socked head cap screw	M8x25	DIN 912	*) 14.01.040.01031955-01
11	1	screw connection	PG16		14.80.005.0008
12	1	sealing plug	M 16x1,5		14.80.070.0000
13	1	rubber disk			14.80.070.0001
14	1	electric connection bag			***) 14.80.000.0002
15	1	washer of cover of terminal box			*) 14.80.121.0000
16	1	cover of terminal box			14.80.080.0014
17	6	schnorr-lock washer	S6		*) 14.01.042.08470108-01
18	6	hexagon socked head cap screw	M6x20	DIN 912	*) 14.01.040.01031489-01
	1	set fuse elements GE20			14.80.000.0010

X Depending on the motor type; please contact the manufacturer for product selection, stating the serial number of the motor.

*) Included in the set of fuse elements

**) In case of delivery of the motor without connecting cables, a connection bag will be supplied.